

GT-11 / BGT-11

The multifunctional GPS handheld navigator and data logger

Welcome

Congratulations for choosing **GT-11/BGT-11!** We hope you will agree it is an excellent navigator. We want you to have a very pleasant outdoor experience with **GT-11/BGT-11** so please check the content in the package first. If you find any parts missing, please contact your LOCOSYS authorized dealer immediately. All our dealers are ready and willing to help.

This manual provides detailed instructions for operating **GT-11/BGT-11**. To fully understand all the features and functions, please take some time to read through the manual before using **GT-11/BGT-11**. Some useful tips are also included in this manual. We hope **GT-11/BGT-11** will enhance your enjoyment of outdoor activities whether with your friends, family, classmates and colleagues.

Please visit our website and send us your comments. From time to time, we will have updates and upgrades available - based on your suggestions and recommendations. Have fun with your **GT-11/BGT-11!**

Sincerely yours,
LOCOSYS Technology Inc.

Package Check List

Standard package:

1 GT-11/BGT-11

1 USB data/charge cable

1 Installation CD,
containing:

Owner's Manual,
Drivers, and Utilities

* Contact your dealer if any
parts are missing.

Options:

- USB Car Charger
- USB Travel AC/DC adapter
- Bike Mounting Kits
- Wrist/Arm Strap
- USB AA battery adapter
- USB Power Bank

* Ask your dealer for detail

From the Editor

One of my Japanese friends once told me: “I can manage our language, which has hundreds of different characters; but I just can’t manage a language that has only 26 characters or letters.”

“Yes, indeed,” I answered, “There are thousands of different characters in my native language, I can manage over 90% of them; Unfortunately, I’m also unable to manage a language which has only 26 characters.”

It’s hard to learn English. Let me show you some examples: you fill in a form by filling it out and an alarm clock goes off by going on. You get in and out of a car, yet you get on and off a bus. When the stars are out, they are visible, but when the lights are out, they are invisible. And why, when I wind up my watch, I start it, but when I wind up this essay, I end it? English is a strange language ... it doesn't seem know if it is coming or going!

I sincerely hope **GT-11/BGT-11** may guide you where to go. Should you have any questions or comments on this manual, please feel free to let us have your feedback. It would be our great pleasure to improve this manual for you.

Sincerely your,
The Editor
LOCOSYS Technology Inc.

Warning and Cautions

Taking your eyes off the road can cause accidents and serious damage or personal injury. Do not change any settings on **GT-11/BGT-11** while driving or riding. Come to a complete stop or have your passenger make any changes. Do not secure **GT-11/BGT-11** over airbag panels or in a place where the driver or passengers are likely to come into contact with it in the event of an accident or collision. Never dispose of the **GT-11/BGT-11** in a fire. This can cause the built-in lithium-ion polymer rechargeable battery to explode. If, for any reason, the electrolytic liquid of the battery comes into contact with the skin or the eyes, flush with plenty of water and call for medical help immediately.

The GPS system is operated and maintained by the government of the United States, which is solely responsible for the accuracy and maintenance of the GPS. The system is subject to change which could affect the accuracy and performance of all GPS equipment.

Accuracy can also be affected by poor satellite geometry and by various other causes. Do not rely solely on this device for precision measurement or navigation.

The **GT-11/BGT-11** does not contain any user serviceable parts. Please contact our authorized dealers for repair. Unauthorized repair will void the warranty.



Table of Contents

Welcome	2	NAVI LINK	39
From the Editor	3	Settings	40
Warnings and Cautions	4	Miscellanies	46
Table of Contents	5	How to.	
Introduction to GT-11/BGT-11	6	Track back to where you came on	47
Controls	8	Calculate the area	49
Power/ESC Button	8	Download and Upload the data	50
Thumb Stick Operation	8	Update firmware	55
Fast Mark	8	Appendix	
Before Getting Started	9	Map datum list	56
Status Indicators	10	Warranty and Repair	64
Introduction to the pages		Federal Communications	66
Page System Tree	11	Commission (FCC) Statement	
Main Menu	13		
Satellite Signal	14		
Trip Meter	15		
Navigation	17		
Track	20		
Position Mark	26		
Waypoint	27		
Route	31		
Memory Card	36		

**Treasure your
GT-11/BGT-11 the
same way treasure
your bike**



Introduction to GT-11/BGT-11



The **GT-11/BGT-11** is a wonderfully compact, business card sized navigator, carefully designed to embody ergonomic principles. It will comfortably fit in the palm of your hand, mount on the handlebar of bike or motorcycle, and can even be worn on your wrist or arm. The stylish unit can stand on your desk as a funky gadget, or, more usefully, can be placed on the dashboard in your car.

The **GT-11/BGT-11** can run for up to **32 hours** in power saving mode with the built-in lithium ion polymer rechargeable battery. It can be recharged while connected to car cigarette lighter, mains power outlet, or your PC/Notebook. When traveling where no car or mains power is available, you may purchase an AA battery adapter, or a rechargeable power bank (Solar charger) to extend the usage.

A state-of-the-art Thumb Stick allows for simple, one-handed operation. This rugged navigator is waterproof to IPX7 standards or, immersible in the water for 30 minutes at a depth of 1 meter, and, **it floats!**

GT-11/BGT-11 is not only developed to handle outdoor activities, but also to handle various professional uses, such as speed, hazard area, zone alerts, altitude, or other alerts defined by the user. To store trip data for longer journeys, there is a SD/MMC slot for extra data storage capacity.



Introduction to GT-11/BGT-11(continued)

FRONT



BACK

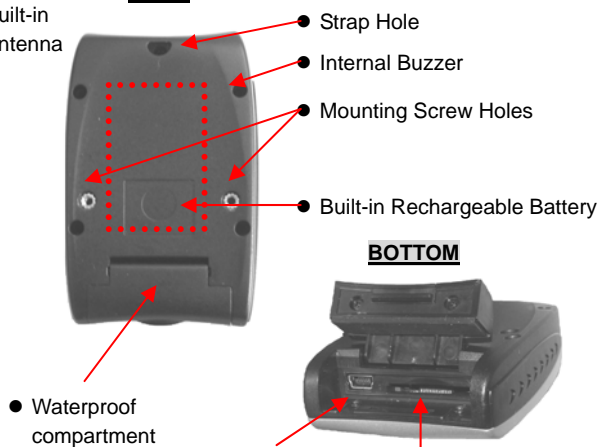

BOTTOM

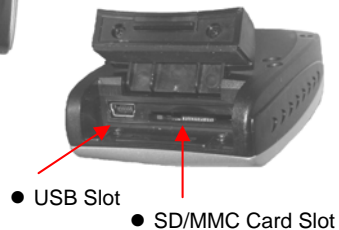

Controls

POWER/ESC BUTTON

- Press this button and hold to **Power ON**
- Press this button and hold to **Power OFF**
- When power is turned on, this button functions the same as **ESC**.
- Press **in** to escape the current page
- Under any Main Page, it is also used as a toggle key to turn **On/Off the Backlight**



THUMB STICK (TS) OPERATION

- It's a 5-way directional controller.
- Move the **TS Up, Down, Left, or Right** to highlight the option.
- Press **In** the **TS** to confirm, or execute the option.
- Press **Power/ESC** button to escape the current page.

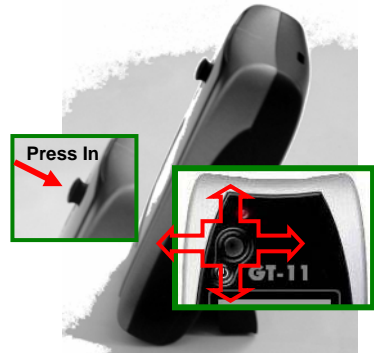

FAST MARK

- At any stage, press **In and Hold** the **TS**, and the current location will be automatically saved as a waypoint. You may edit it later.
- This feature is available **only when** the position has been **fixed**

Before Getting Started

GT-11/BGT-11 is designed for easy operation. If this is the first time you have owned a GPS navigator, just follow the instructions in the following pages and you will be quickly become familiar with this unit.

Before Use

- 1) **Charge the battery.** It takes around 4 hours for the built-in battery to charge fully.
- 2) **Initialize the receiver.** Leave the **GT-11/BGT-11S** outside with a clear view of sky until it has fixed its position. After that, it needs only around 45 seconds to find its location. When the unit has not been used for long time, or it's taken to a far distance from where you initialized it, you will need to re-initialize the unit before use.
- 3) **Configure the system.** Set up the parameters under the Settings page. The system will store your configuration on its built-in flash memory.
- 4) **Consult with your dealer or contact us,** if you have any question about setting up the **GT-11/BGT-11**. We will be pleased to assist get familiar with the unit.

- 5) **Mark and edit waypoints, and create a route** (refer to Mark, Waypoint, and Route pages for details)

GT-11/BGT-11 can now tell you:

- Where you are
- Where you have been
- Where you are going
- How did you made up your trip, and
- Many other interesting possibilities.....

**The greatest discovery of my generation
is that a human being can alter his life by
altering his attitudes of mind.**

William James (1842-1910)

Status Indicators

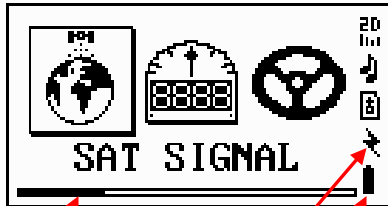

● Scroll Bar

● Battery indicator

● External Power and Other indicators:



External Power Mode: appears when external power source is connected.



Alert indicator appears when approaching to a waypoint which has been predefined for alerting.



Over-speed indicator appears when speed exceeds the preset speed.

● Positioning indicators:



Positioning with 3D fixed



Positioning with 2D fixed



Acquiring signal



Bluetooth is working *

● Buzzer function Indicator:



Enabled



Disabled

● Memory Card Indicator:



Memory card is correctly inserted.



Flashing when the system is writing on the card.



Memory card is full and can be removed safely.



Memory card is correctly inserted but write-protected.

● Altitude Alert Indicator appears when altitude reaches the preset altitude.



* Only for BGT-11

Page System Tree

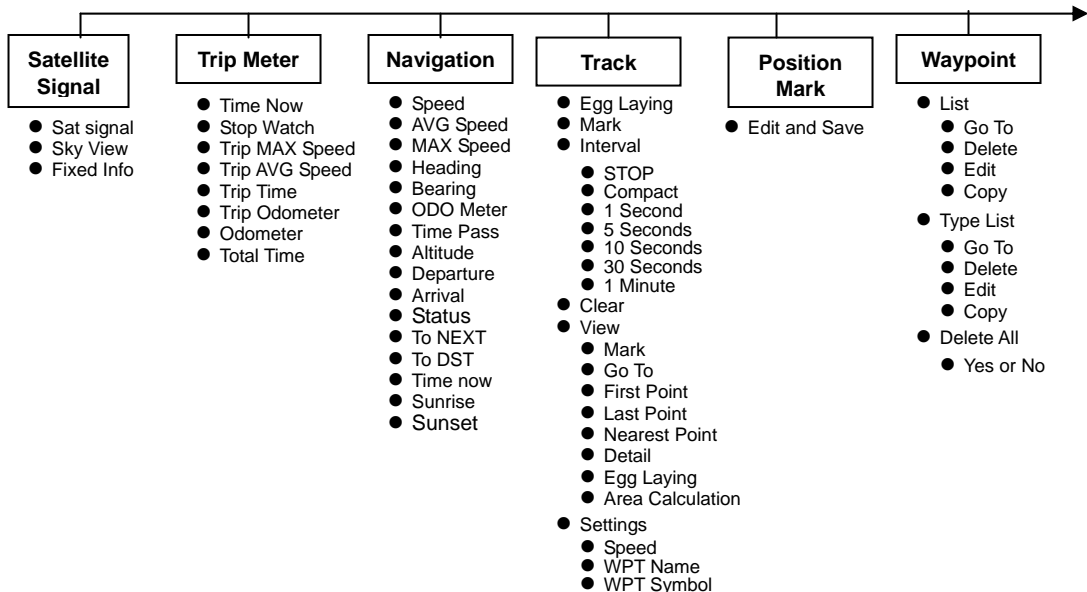

Page System Tree (continued)

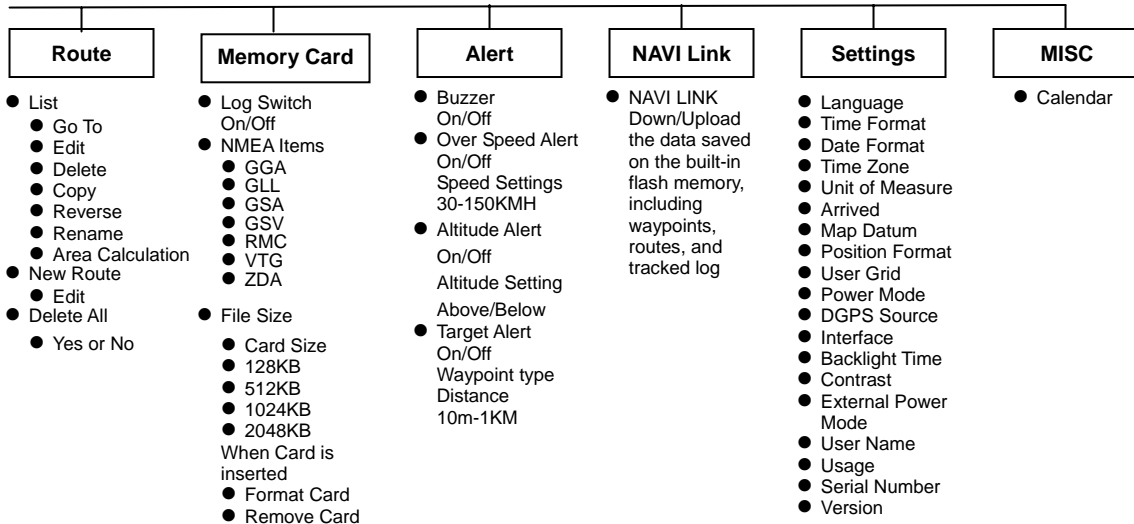

Main Menu

Page Tree

- Satellite Signal
- Trip Meter
- Navigation
- Track
- Position Mark
- Waypoints
- Routes
- Memory Card
- Alert
- NAVI LINK
- Settings
- MISC



Satellite signal and fixed info



Provides the information on your movement



Navigating along your routes



The current and historical direction of movement



Marking a location for future reference or for other uses



The database of destination points



The courses you plan to navigate along

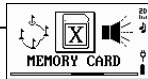

Setting up the files to be logged on external memory



Setting up alarms



Connecting to host PC to

- download the waypoints, routes, tracked points that are saved on built-in flash memory, or
- upload the waypoints and routes from host PC to the built-in flash memory on the unit



Configuring the system



A calendar up to the year 2060

Satellite Signal

There are three pages providing the detailed information related to GPS signals.

Page Tree

- Sat Signal
- Sky View
- Fixed Info

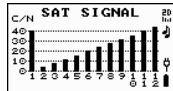

GPS Signal

- Satellite signal strength bars. The longer bar, the stronger the GPS signal
- The ID of the GPS being seen

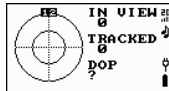

SKY View

- Satellite position. The two circles indicate satellite elevation as seen from your current position
- Satellite number being seen
- Satellite number being tracked
- DOP - Position Dilution of Precision. The lower the better

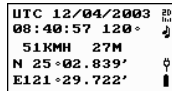

GPS Fixed Info

- Day, Month, Year.
- Time, Heading
- Velocity, Altitude.
- Current Location Coordinates

Trip Meter

Page Tree

- Time Now
- Stop Watch
- Trip MAX Speed
- Trip AVG Speed
- Trip Time
- Trip ODO
- Total ODO
- Total Time

The Trip Meter pages provide Current Speed, Trip Timer, Average Speed, ODO Meter, and more. All the meter pages have a similar format as follows:

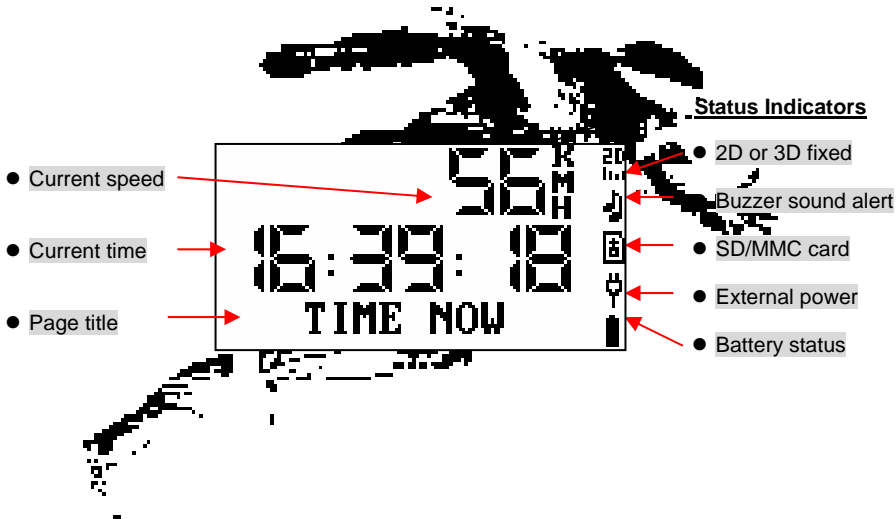

Trip Meter (continued)

Page Tree

- Time Now
- Stop Watch
- Trip MAX Speed
- Trip AVG Speed
- Trip Time
- Trip ODO
- Total ODO
- Total Time



- Press in the TS to Pause, Zero, or Count

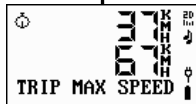
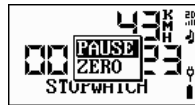

- Maximum speed during the trip since last trip reset

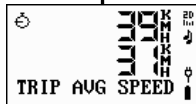

- Average speed during the trip - derived from TRIP ODOM and TRIP TIME

All the meters can be reset.

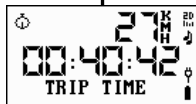
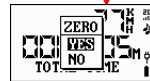

- Time elapsed for the trip since last trip reset

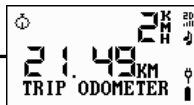

- Accumulated mileage during the trip since last trip reset



- Total accumulated mileage



- Total accumulated time

Navigation

Page Tree

- Speed
- AVG Speed
- MAX Speed
- Heading
- Bearing
- ODO Meter
- Time Pass
- Altitude
- Departure
- Arrival
- Status
- To NEXT
- To DST
- Time now
- Sunrise
- Sunset

The navigation pages provide the direction you are moving, current time, speed, altitude, and other trip computer information.

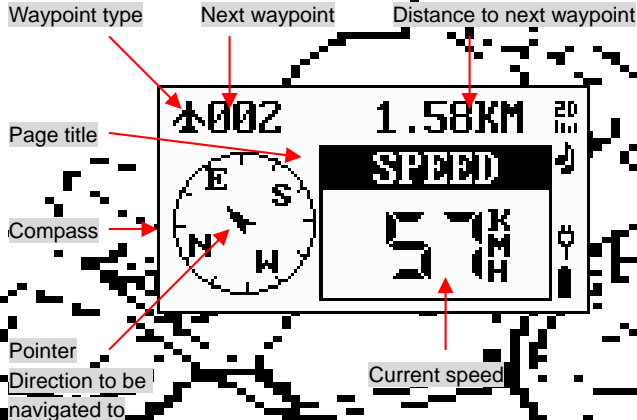

Navigation features will be activated only when a route or waypoint has been selected for navigation. Otherwise the page will show READY FOR NAV.



When the waypoint has been reached, this page will show:



Navigation (continued)

Page Tree

- Speed
- AVG Speed
- MAX Speed
- Heading
- Bearing
- ODO Meter
- Time Pass
- Altitude
- Departure
- Arrival
- Status
- To NEXT
- To DST
- Time now
- Sunrise
- Sunset

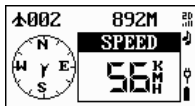

- The current speed

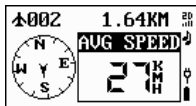

- The average speed of the trip

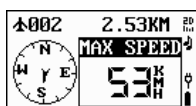

- The maximum speed of the trip

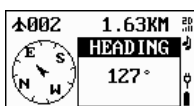

- The direction you are traveling



- The direction of your destination

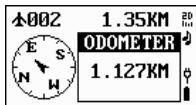

- Accumulated mileage

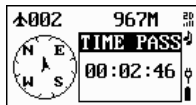

- Total time elapsed of the trip

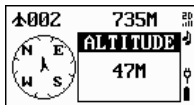

- Current altitude



- The time of departure

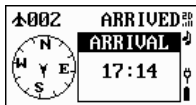

- The time arrived at the destination

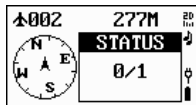

- Waypoint(s) reached.
- Total waypoint(s) of this trip

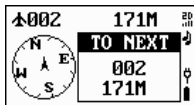

- Name of next waypoint
- Distance to next waypoint

Navigation (continued)

Page Tree

- Speed
- AVG Speed
- MAX Speed
- Heading
- Bearing
- ODO Meter
- Time Pass
- Altitude
- Departure
- Arrival
- Status
- To NEXT
- To DST
- Sunrise
- Sunset
- Compass

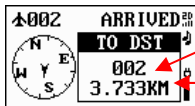

- Name of destination waypoint
- Distance to destination



- The time sun rises at the current location



- The time the sun sets at the current location

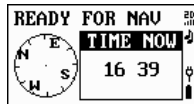

- At any pages under Navigation, you may press in the **TS** to select the larger compass display.

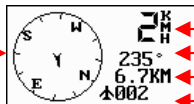

- Current speed
- Bearing
- Distance to destination
- Type and Name of destination waypoint



For any reason, you may cancel, or skip current navigation of the trip.

- When CANCEL is selected, current navigation function will be disabled
- When SKIP is selected, the current navigation function will remain effective, but will skip the waypoint that is navigating to, and jump to the next waypoint.

Track

Track pages provide two types of movement information:

- The active movement of the trip (**Egg Laying** page)
- The historical movement of the trip (**View** page)

- The track data is logged on the built-in flash memory of **GT-11/BGT-11**.
- Up to 8192 points can be logged
- **To log the track data, you first need to set the Interval.**
- **In View mode, the system will stop to log active movement.**

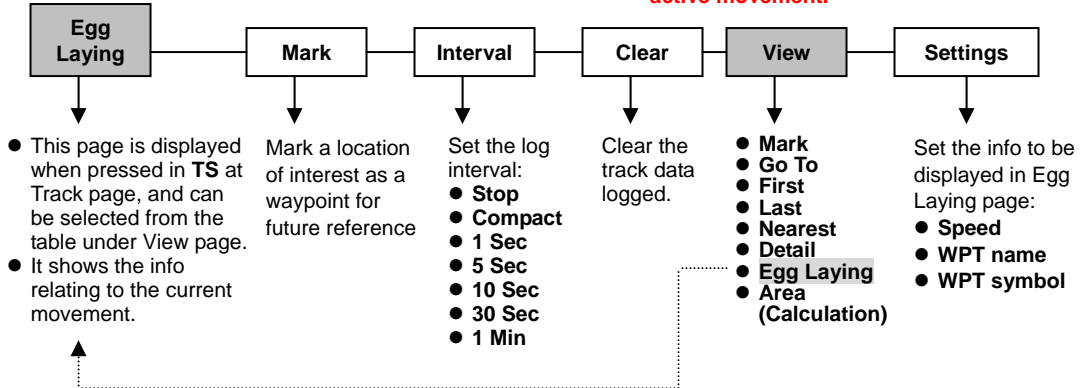

Track (Egg Laying)

Page Tree

- Egg Laying
- Mark
- Interval
 - STOP
 - Compact
 - 1 Second
 - 5 Seconds
 - 10 Seconds
 - 30 Seconds
 - 1 Minute
- Clear
- Detail
- View
 - Mark
 - Go to
 - First Point
 - Last Point
 - Nearest Point
 - Detail
 - Navigation
 - Area Calculation
- Settings
 - Speed
 - WPT Name
 - WPT Symbol

Under Track page, when press in the **TS**, under Track page, the screen will show the current movement with an egg laying drawing. The Current Speed, Waypoint Name, and Waypoint Symbol can be selected to display or not to display under Setting page.

- North pointer
- Waypoint Name
- Waypoint Symbol
- Current speed

● Track points

● Scale

The scale can be adjusted by scrolling the **TS Up** or **Down**, from 15m to 260KM

● Usage status bar chart

Up to 8192 track points can be logged in the track database

Track (continued)

Page Tree

- Egg Laying
- Mark
- Interval
 - STOP
 - Compact
 - 1 Second
 - 5 Seconds
 - 10 Seconds
 - 30 Seconds
 - 1 Minute
- Clear
- View
 - Mark
 - Go To
 - First
 - Last
 - Nearest
 - Detail
 - Egg Laying
 - Area Calculation
- Settings
 - Speed
 - WPT Name
 - WPT Symbol

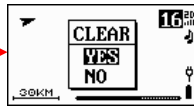
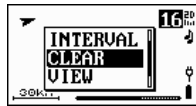
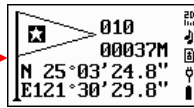

- While the **TS** is pressed in, the current location will be marked as a waypoint.
- Refer to Position Mark page for further details.

- To set the log frequency
- It can be set to log from 1, 5, 10, 30 second, to 1 minute intervals.
- If Compact is selected, the displayed points will be automatically adjusted for better view.

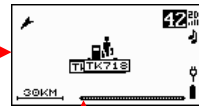

- To clear the logged tracking data

- When Clear is selected, it will jump to the Egg Laying page automatically, and the Usage Status Bar Chart will be cleared.

Track (continued)

Page Tree

- Egg Laying
- Mark
- Interval
 - STOP
 - Compact
 - 1 Second
 - 5 Seconds
 - 10 Seconds
 - 30 Seconds
 - 1 Minute
- Clear
- View
 - Mark
 - Go To
 - First
 - Last
 - Nearest
 - Detail
 - Egg Laying
 - Area Calculation
- Settings
 - Speed
 - WPT Name
 - WPT Symbol

View: When View page is selected, it will show the detail of the tracked information:

Note : While View Page is selected, the system will stop the track logging.

- North Up pointer

In View mode, it always shows north up.

- The point being requested to display the detail.

- Range scale
Scroll **Up** and **Down** with the **TS** to adjust.
It can be adjusted from 15m to 260 KM.

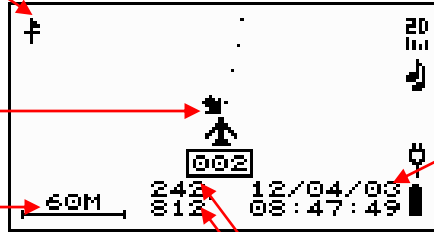

- The date/month/year and time the point was logged.

- The number of point being displayed
- Total number of points being logged

Track (continued)

Page Tree

- Egg Laying
- Mark
- Interval
 - STOP
 - Compact
 - 1 Second
 - 5 Seconds
 - 10 Seconds
 - 30 Seconds
 - 1 Minute
- Clear
- View
 - Mark
 - Go To
 - First
 - Last
 - Nearest
 - Detail
 - Egg Laying
 - Area Calculation
- Settings
 - Speed
 - WPT Name
 - WPT Symbol

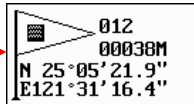

- Pressing in the **TS** will mark the track point you have selected. The marked point will be automatically assigned a numerical waypoint name. You may edit it with new name and new type.



- While GO TO is selected, the page will jump to Navigation automatically.

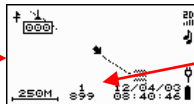

- While pressing in the **TS**, the page will show the first point since this trip being logged.

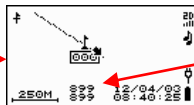

- While pressing in the **TS**, the page will show the last point since this trip being logged.

Track (continued)

Page Tree

- Egg Laying
- Mark
- Interval
 - Compact
 - STOP
 - 1 Second
 - 5 Seconds
 - 10 Seconds
 - 30 Seconds
 - 1 Minute
- Clear
- View
 - Mark
 - Go To
 - First
 - Last
 - Nearest
 - Detail
 - Egg Laying
 - Area Calculation
- Settings
 - Speed
 - WPT Name
 - WPT Symbol

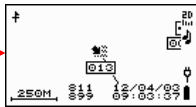

- The page will show the nearest track point logged to current position.
- Any one of the track points can be marked as a waypoint by pressing in the **TS**.

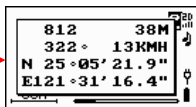

- Pressing in the **TS**, the page will show number of the track point, altitude, heading, speed, and the coordinates of the point being selected.



- Pressing in the **TS**, the page will jump to the Egg Laying page and resume the track logging.



- The system may calculate the area based on the track points traveled, including the distance from the first point to the last point.
- Refer to the page of **How to Calculate Area** for further details

Position Mark

Description

You may mark the current location as a waypoint and then edit it for future reference. The same page may be accessible from **Track** and **Route** pages.

- Pressing in the **TS**, the page will show the detail of current location, and automatically generate a waypoint name in numerical order.
- All the items can be edited
- Scroll **TS** to highlight the item and press **in** to edit it
- Press **ESC** to show the saving selection
- Scroll **TS** to highlight next item or press **ESC** to save

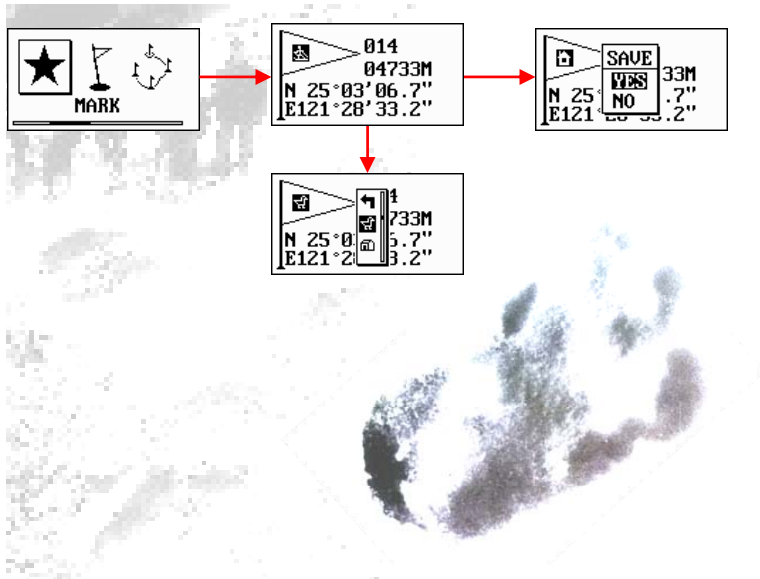

Waypoint

Description

Waypoint is one of the most important elements of navigation. You will need to either mark a position of interest, or edit a known location as a waypoint to activate the **Navigation** function. The location information in the Waypoint is described below. All of the waypoints can be edited.

- Waypoint type

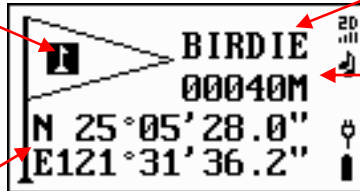

- Location coordinates

- Waypoint name

- Altitude

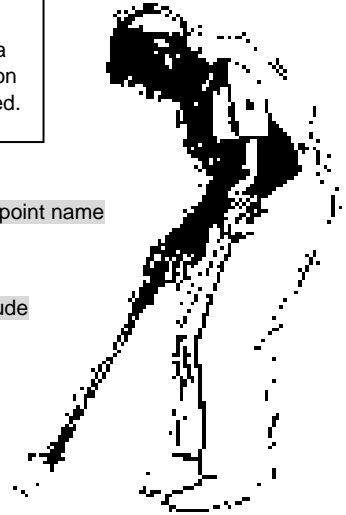

Waypoint (continued)

Page Tree

- **List**
 - Go To
 - Delete
 - Edit
 - Copy
- **Type List**
 - Go To
 - Delete
 - Edit
 - Copy
- **Delete All**
 - In use
 - Yes or No

Description

All the waypoints in database can be displayed by name in alphabetical order (LIST) or by types (TYPE LIST). Then you may select GO TO, Delete, Edit or Copy. Or, you can delete all the waypoints in the database.

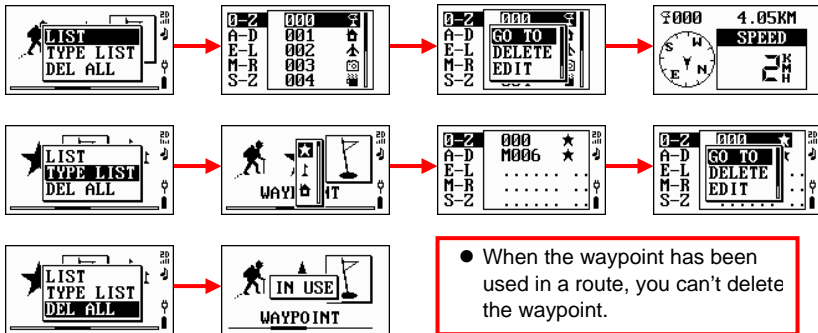

- When the waypoint has been used in a route, you can't delete the waypoint.

Waypoint (continued)

Page Tree

- List
 - Go To
 - Delete
 - Edit
 - Copy
- Type List
 - Go To
 - Delete
 - Edit
 - Copy
- Delete All
 - In use
 - Yes or No

GO TO

Select the waypoint to navigate

- Highlight the waypoint you want to navigate to.
- Press in the **TS**, the page will jump to Navigation page automatically.



EDIT

You can change the waypoint type, name, coordinates, and distance:

- When EDIT is selected, the screen will display the details of the waypoint to be edited
- Scroll the **TS Up** or **Down** to select the item(s) you want to edit and press in the **TS** to confirm the selection.
- When EDIT has been completed, press the **ESC** button to save the edition.

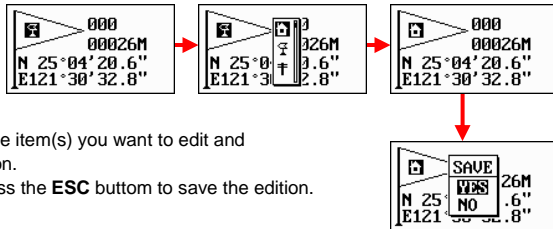

DELETE

When a waypoint is no longer required, you can delete it from database:

- Highlight the waypoint you want to delete.
- Press in the **TS**, and select Delete to delete the waypoint.

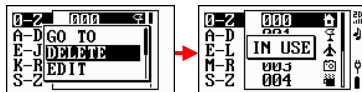

- When the waypoint is being used in a route, you can't delete it

Waypoint (continued)

Page Tree

- List All
 - Go To
 - Delete
 - Edit
 - Copy
- By Type
 - Go To
 - Delete
 - Edit
 - Copy
- Delete All
 - In use
 - Yes or No

COPY

You can copy the waypoint in the database for future use.

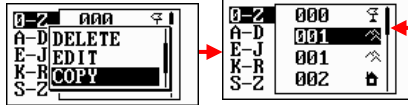

- Waypoint 001 has been copied

Always carry a first aid kit

There are many bad things that can happen in the outdoors, from minor cuts and bruises, bites or stings, to more serious things like broken bones and head injuries. It always pays to be prepared, and the added weight of a first aid kit is fairly insignificant. Contact your local stores. There are several available specifically designed for day-trippers and backpackers, and.....

- Carry GT-11/BGT-11 with you -



Route

Page Tree

- **List**

- Go To
- Edit
- Delete
- Copy
- Reverse
- Rename
- Area Calculation

- **New Route**

- Edit
- **Delete All**

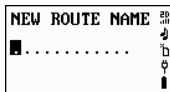
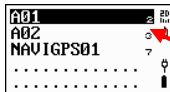

- When selected, the page will display all the routes in the database, and,
- The total number of waypoints in each route.

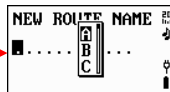

- A total of 20 routes can be created.
- Up to 13 alphabetical characters can be used for the route name
- Max 125 waypoints can be used per route

- When selected, all the routes in the database will be deleted.

- When system is in navigating mode, the route cannot be deleted.

Route (continued)

Page Tree

- List
 - Go To
 - Edit
 - Delete
 - Rename
 - Copy
 - Reverse
 - Area
- New Route
 - Edit
- Delete All

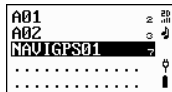

- Scroll with the **TS** to highlight the route and press in. The page will show related features for this route.

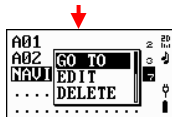

- Press in the **TS**, the page will jump to Navigation and navigate to the first waypoint in that route.

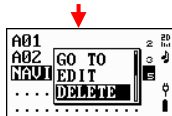

- When a route is no longer required, you can delete it from the database.

When **GT-11/BGT-11** is navigating, you can't delete the route.

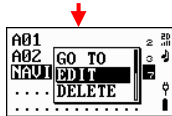
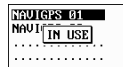

- You can edit the route with the waypoints in the database.

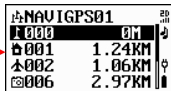

- When pressed in the **TS**, it will show all the waypoints in this route.

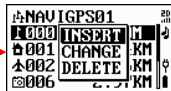

- Press the **TS** in again to show all the waypoints in the waypoint database.

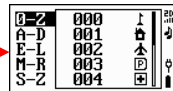

- You can edit the route with the waypoints in the database.
- Scroll with the **TS** to select.
- Press in to confirm the selection.

Route(continued)

Page Tree

- List All
 - Go To
 - Delete
 - Edit
 - Copy
 - Reverse
 - (trackback)
 - Rename
 - Area Calculation
- New Route
 - Edit
- Delete All

Continued from previous page

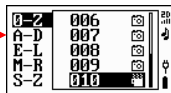
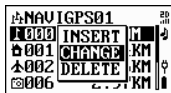

- Select the waypoint you wish to insert and press in to confirm the selection.



- Press in the **TS** to delete the waypoint from the route

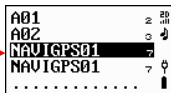

- When the **TS** is pressed in, the route name and the waypoints in the route will be copied.

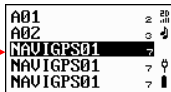

- Reverse is functioned similar to backtracking.
- When the **TS** is pressed in, The route name will be copied and all the waypoints in this route will be in reversed order.



- Press the **TS** in again to edit the name of route

Memory Card

Page Tree

- Log Switch
 - On or Off

- NMEA Items

- GGA
- GLL
- GSA
- GSV
- RMC
- VTG
- ZDA

- File Size

- Card Size
- 128KB
- 512KB
- 1024KB
- 2048KB

When the card is correctly inserted

- Format Card
- Remove Card

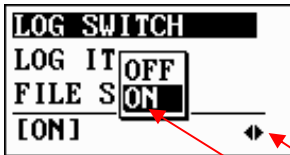

- Scroll with the **TS Up** or **Down** to highlight the option
- Press in the **TS** to display the option
- Scroll **Up** or **Down** to select the option, and press in to confirm



- Move the **TS** to **Right** or **Left** to select the setting
- Set the log switch **ON** to activate the memory card logging

● Insert SD/MMC card here



- The system accepts SD or MMC cards up to 2GB.
- When SD or MMC card inserted, the screen will display **CARD FOUND**
- The indicator will be displayed If the card is correctly inserted.

Memory Card (continued)

Page Tree

- Log Switch
 - On or Off
- NMEA Items
 - GGA
 - GLL
 - GSA
 - GSV
 - RMC
 - VTG
 - ZDA
- File Size
 - Card Size
 - 128KB
 - 512KB
 - 1024KB
 - 2048KB

When the card is correctly inserted

- Format Card
- Remove Card



- Marked items are being activated.

- GGA is being set to log at 1 second rate.
- GLL is being set not to log.
- GSA is being set to 1 second.



NMEA-0183 sentences:

- GGA:** Global Positioning System fixed data
- GLL:** Geographic position - latitude/longitude
- GSA:** GNSS DOP and active satellites
- GSV:** GNSS satellites in view
- RMC:** Recommended minimum specific GNSS data
- VTG:** Course over ground and ground speed
- ZDA:** Date and time

Please refer to NMEA 0183 format for further details.

- **NMEA-0183** format is defined by the National Marine Electronics Association (NMEA), Standard for Interfacing Marine Electronic Devices, Version 2.20, January 1, 1997.

Memory Card (continued)

Page Tree

- Log Switch
 - On or Off
 - NMEA Items
 - GGA
 - GLL
 - GSA
 - GSV
 - RMC
 - VTG
 - ZDA
 - File Size
 - Card Size
 - 128KB
 - 512KB
 - 1024KB
 - 2048KB
- When the card is correctly inserted
- Format Card
 - Remove Card



- Select proper size to log the track data.
- File sizes can be set:
128, 512, 1024, 2048 KB, or card size
- When CARD SIZE is selected, the system will store the data on the card continuously until the card memory is full.

Note:

To prevent data lost on the memory card, **GT-11/BGT-11** will store the data up to the file size selected, and generates a file automatically. And then, start again to store the data until file size selected has been reached. A new file will be generated accordingly. Therefore, it is safer to select small file size. However, it also depends on post-processing requirement to select file sizes.

If the card is properly inserted, the following pages will be shown:

- **Format Card:** Format the card to FAT16 file system.
Note: All data on memory card will be erased when the Format Card has been selected.
- **Remove Card:** Before taking out the memory card, execute this function to save the file, or the file could be damaged.

Alert

Page Tree

- Buzzer
On/Off
- Over Speed
On/Off
Speed Setting
- Altitude
On/Off
Above/Below
Altitude Setting
- Target
On/Off
Waypoint type
Setting

Description

GT-11/BGT-11 generates audio and visual signals through a Buzzer and LED. These signals can be used to provide Over Speed, Altitude or other alerts defined by the user.

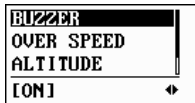

- Select to turn on the audio alert.
- LED will be on automatically when anyone of the alerts is activated.

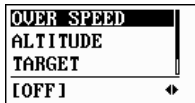

- Select the Speed or disable (OFF) the Over Speed alert.
- The over speed alert can be set from 30KM/H to 150 KM/H.

Alert (continued)

Page Tree

- Buzzer
On/Off
- Over Speed
On/Off
Speed Setting
- Altitude
On/Off
Above/Below
Altitude Setting
- Target
On/Off
Waypoint type
Setting

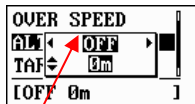
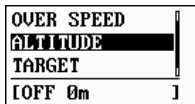

- Move the **TS Left** or **Right** to select **Below** or **Above** alerts

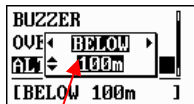

- Scroll **up** or **down** the **TS** to select approaching altitude for the alert
- The range is from **0M** to **15240M**.
- **GT-11/BGT-11** will automatically alert you when approaching the selected altitude.

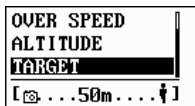
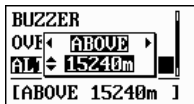

- This product can automatically alert you when approaching the target.

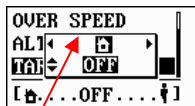

- Move the **TS Left** or **Right** to select the **target** alert (using waypoint types).

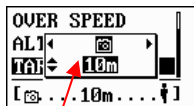

- Scroll **up** or **down** the **TS** to select the approaching distance for the alert.
- The range is from **10M** to **1KM**.

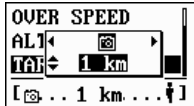

NAVI LINK

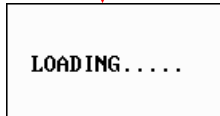

NAVI LINK feature is to provide the connection between the unit and the host PC/Notebook to download or upload the data.

- Download data includes: **Way points, Routes, and track points** stored on the built-in flash memory.
- Upload data includes: **Way points and Routes**

- Before downloading or uploading, make sure the driver USB-Comm Port has been successfully installed on your host PC/Notebook. This driver is coming with the package in the Installation CD. Or you can download the driver from our web.
- When data transfer has been completed, press the **Power/ESC** button to reboot the unit.
- Please refer to **How to Download and Upload the Data** in this manual for further details

Settings

Page Tree

- Language
- Time Format
- Date Format
- Time Zone
- Unit of Measure
- Arrived
- Map Datum
- Position Format
- User Grid
- Power Mode
- DGPS Source
- Interface
- Backlight Time
- Contrast
- External Power Mode
- Bluetooth*
- User Name
- Usage
- Serial Number
- Version



- The selected option is shown when the page is highlighted

- Currently there is only English language available. Other languages, such as French, Spanish, Russian, Chinese classic, and Chinese simplified will be available downloaded from our web site.

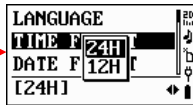
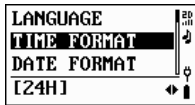

- Select 24 Hour, or 12 Hour time formats



Three formats may be selected

- Date-Month-Year
- Month-Date-Year, or
- Year-Month-Date

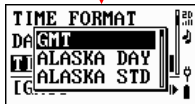

- Select the time zone you are in. 25 cities or states are included in the table.
- If you can't find the time zone you need in the table, select **Others** and set the time difference.

Continued to next page

Settings (continued)

Page Tree

- Language
- Time Format
- Date Format
- Time Zone
- Unit of Measure
- Arrived
- Map Datum
- Position Format
- User Grid
- Power Mode
- DGPS Source
- Interface
- Backlight Time
- Contrast
- External Power Mode
- Bluetooth*
- User Name
- Usage
- Serial Number
- Version

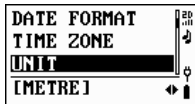
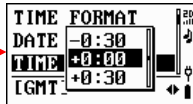
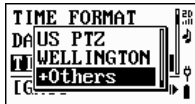

Metric (meter) or Imperial (feet) measuring systems can be selected

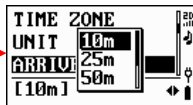
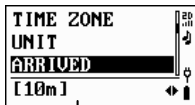

Set the distance to indicate the arrival at destination or waypoint

Continued to next page

Time Zone in Database

GMT	New Delhi
Alaska Day	Rome
Alaska STD	Sydney
ALT STD	Taipei
AST DAY	Tokyo
Azores	US CTZ
Baku	US ESZ
Bangkok	US MT2
Brazilia	US PT2
Dhakar	Wellington
Eniwetok	*Others
Hawaii	
Hong Kong	
Israel	
Moscow	

Settings (continued)

Page Tree

- Language
- Time Format
- Date Format
- Time Zone
- Unit of Measure
- Arrived
- Map Datum
- Position Format
- User Grid
- Power Mode
- DGPS Source
- Interface
- Backlight Time
- Contrast
- External Power Mode
- Bluetooth*
- User Name
- Usage
- Serial Number
- Version

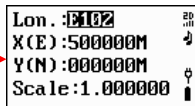
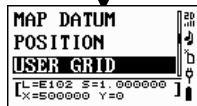
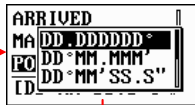
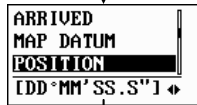
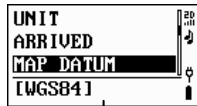

Continued to next page

- The default map datum setting is WGS-84.
- There are over 180 map data that can be selected in the database. Refer to Appendix 1 for the list.
- You may define your own map datum in the USER GRID page.

- **MGRS**
– Military Grid Reference System
- **User Grid**
– the format defined in the USER GRID page
- **UTM**
– Universal Transverse Mercator Projection Grid System

- The position format can be defined to meet specific needs

Settings (continued)

Page Tree

- Language
- Time Format
- Date Format
- Time Zone
- Unit of Measure
- Arrived
- Map Datum
- Position Format
- User Grid
- Power Mode
- DGPS Source
- Interface
- Backlight Time
- Contrast
- External Power Mode
- Bluetooth*
- User Name
- Usage
- Serial Number
- Version

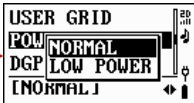
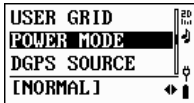

- When Low Power mode is selected, the unit may run up to **32 hours**. However, it is recommended to use it in a clear view environment.

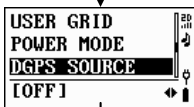

- When proper SBAS, such as WAAS, or Serial DGPS source is fed in, the accuracy can be better than **3 meters**.

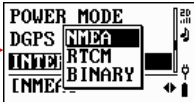
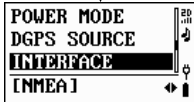

There are three different interfaces:

- NMEA: To output NMEA0183 format data
- RTCM : To receive RTCM SC-104 correction data
- SiRF Binary protocol: To input/output SiRF Binary data

- DGPS feature will be automatically disabled when Low Power mode is activated.

NMEA Output rate

- GGA: 1 second
- GSA: 1 second
- RMC: 1 second
- GSV: 5 seconds

Continued to next page

Settings (continued)

Page Tree

- Language
- Time Format
- Date Format
- Time Zone
- Unit of Measure
- Arrived
- Map Datum
- Position Format
- User Grid
- Power Mode
- DGPS Source
- Interface
- Backlight Time
- Contrast
- External Power Mode
- Bluetooth*
- User Name
- Usage
- Serial Number
- Version

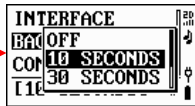
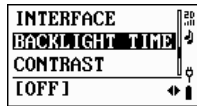

Set the timer for the backlight.

- OFF – backlight will not illuminate.
- 10 Seconds – turned off automatically after 10 seconds.
- 30 seconds – turned off automatically after 30 seconds.
- 1 Minute – turned off automatically after 1 minute.



- Adjust the LCD contrast by moving the thumb stick **Right** or **Left**.

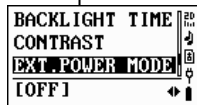

- When **On** is selected, the power to the unit can be controlled by external power source.

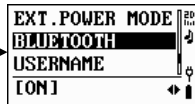

- Turn on/off Bluetooth

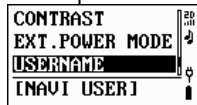

- User's name can be edited with max 13 characters.

Continued to next page

*Only for BGT-11

Settings (continued)

Page Tree

- Language
- Time Format
- Date Format
- Time Zone
- Unit of Measure
- Arrived
- Map Datum
- Position Format
- User Grid
- Power Mode
- DGPS Source
- Interface
- Backlight Time
- Contrast
- External Power Mode
- Bluetooth*
- User Name
- Usage
- Serial Number
- Version

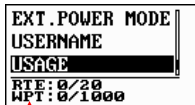

- The usage status of Route and Waypoint.

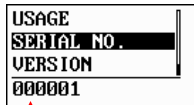

- The Series Number of this product.

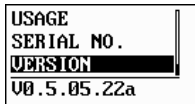

- The version number of firmware.

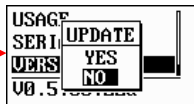

To update the firmware:

- Connect **GT-11/BGT-11** to a PC/Notebook with the USB cable.
- Execute the utilities we provided.
- Follow the instructions to update the firmware.

Miscellanies

Description

This page provides a 120-year calendar for the date information from the year of 1940 to 2060

Operation

- Move the Thumb Stick **up** or **down** to select the **year**
- Move the Thumb Stick **right** or **left** to select the **month**
- Press **in** the Thumb Stick to show the date of **today**

JAN 1940							20
SU	MO	TU	WE	TH	FR	ST	
	1	2	3	4	5	6	♪
7	8	9	10	11	12	13	
14	15	16	17	18	19	20	
21	22	23	24	25	26	27	🕒
28	29	30	31				🕒

DEC 2060							20
SU	MO	TU	WE	TH	FR	ST	
	5	6	7	8	9	10	11
12	13	14	15	16	17	18	
19	20	21	22	23	24	25	🕒
26	27	28	29	30	31		🕒



MAY 2005							20
SU	MO	TU	WE	TH	FR	ST	
1	2	3	4	5	6	7	
8	9				13	14	
15	16	TODAY			20	21	
22	23				27	28	
29	30	31					

Managing You Time

Have a lot of thing to do, but end the day with nothing done?

- Write a To-Do List for tomorrow
- Max 5 items
- Prioritize them
- Work from the number one

How To: Track Back to Where You Came On

If you want to return to the starting point or waypoint where you came from:

- View the logged data under the Track page
- Select the first point where you started the trip
- Press in the **TS** to display the table
- Select Go To and press in the **TS**
- The page will jump to Navigation and guide you the way to go back home.



- Highlight Track and press in **TS** to display the Egg Laying page.

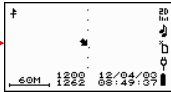
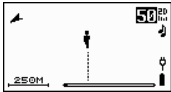

- Press in the **TS** to show the table.
- Highlight VIEW.
- Press in the **TS** again to display the tracking info.



- Press in the **TS** to display the table.
- Highlight First to display the 1st point.
- Press in the **TS** again to display the sub-table
- Highlight Go To, the system will guide you to the first point of your trip.

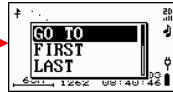
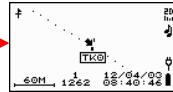

How To: Track Back to Where You Came On (continued)

In addition to using saved waypoints or routes to navigate back where you came from, you may either

- search the waypoint under Waypoint page, then select GO TO, or
- execute the Reverse function to reverse the order of the waypoints in that route, then select GO TO to navigate back the same route you came on:

For Example: If you started from a Gas Station (Waypoint 006), and came here following the Route NAVIGPS01, now you want go back to Gas Station:

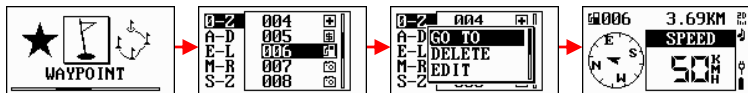

- When Reverse function is activated, the waypoints will be listed in reverse order.
- Highlight the reversed Route, and press in the **TS** to display the table
- Select GO TO.
- The system will navigate back to the way you came.

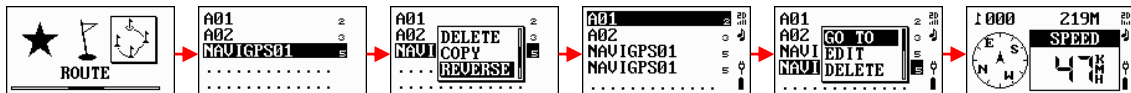

How To: Calculate the Area (Area Calculation)

Area Calculation is a useful feature when you wish to measure an area. There are two pages **ROUTE** or **TRACK** in which you may have the access to this feature:



ROUTE Page

It calculates the area based on the waypoints in a route.

- Press in the **TS** to display the table.
- Select the route you want to calculate the area.
- Press in and select **AREA**
- Press in to calculate.

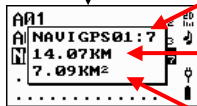
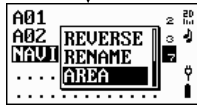
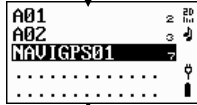

- Route name, total waypoints in the route to be calculated
- The distance from the first point to the last point
- The result calculated



TRACK Page

It calculates the area based on the track logged.

- Press in the **TS** and select **VIEW** page .
- Press in the **TS** again to display the table.
- Move the **TS** to highlight **AREA**.
- Press in the **TS** to calculate.

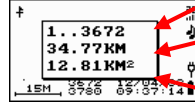
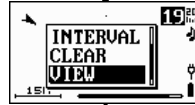

- Total points calculated
- The total distance from the first point to the last point
- The result

How To: Download and Upload Data

The data stored on internal memory (the flash memory in the unit), including the routes, waypoints, logged tracking data, can be downloaded to a PC or Notebook for post analysis or for other applications. The routes and waypoints edited on PC or Notebook can also be uploaded to the unit:

Basic Operation of Downloading or Uploading:

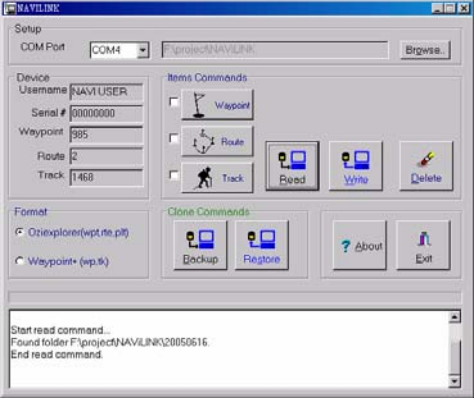
- Make sure the driver of USB-to-Serial Comm Port has been successfully installed on your PC/Notebook.
- Connecting the USB data cable between the unit and your PC/Notebook.
- Power on the unit, and select the NAVI LINK page
- Press in the **TS**, the unit will the show the page illustrated as 
- Execute the utility, **NAVILINK.exe** on your PC/Notebook.
- You will see the page displayed on the screen illustrated as  then select the items you want to download or upload.
- When data transfer has been completed, press the **Power/ESC** button to reset the unit.
- Please refer to the following pages for the detail procedures and formats.

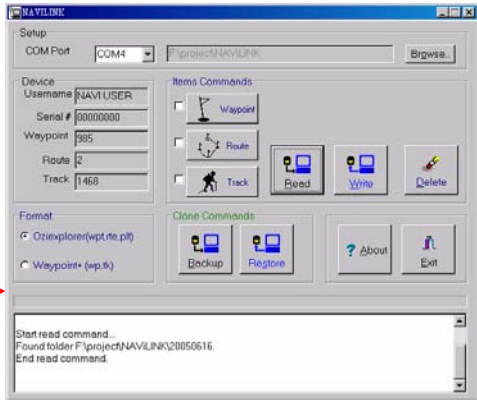

How To: Download and Upload Data (continued)

To Download Data from GT-11/BGT-11 to a host PC

- Step 1:** Select proper “COM Port”
- Step 2:** Change default folder if needed
- Step 3:** Select desired data items in “Items commands” panel
- Step 4:** Select desired data format in “Format” panel
- Step 5:** Press [Read] in “Items commands” panel to start downloading data. While data downloading, the progress bar will display the progress and the related message is shown in the message box below.

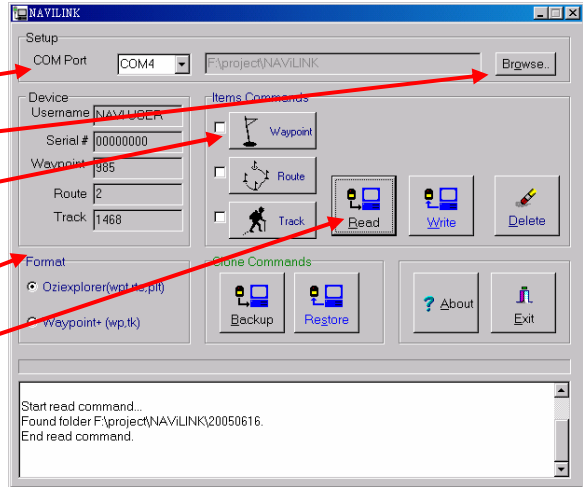

How To: Download and Upload Data (continued)

To Ppload Data from a host PC to the GT-11/BGT-11

Step 1: Select proper “COM Port”

Step 2: Change default folder if needed

Step 3: Select desired data items in “Items
commands” panel

Step 4: Select desired data format

Step 5: Press [Write] in “Items commands” panel
and select files (see **file naming** below) to
start uploading data.

NOTE: Routes will have reference to waypoints.
Follow the steps below to ensure data consistence:

- (1) Backup routes/waypoints if needed
- (2) Delete all routes and waypoints
- (3) Upload new waypoints (*.wpt) first then upload new routes (*.rt). All waypoints referred in the new routes should be already uploaded before uploading routes.

NOTE: The uploaded track will override the original track in the GT-11/BGT-11.

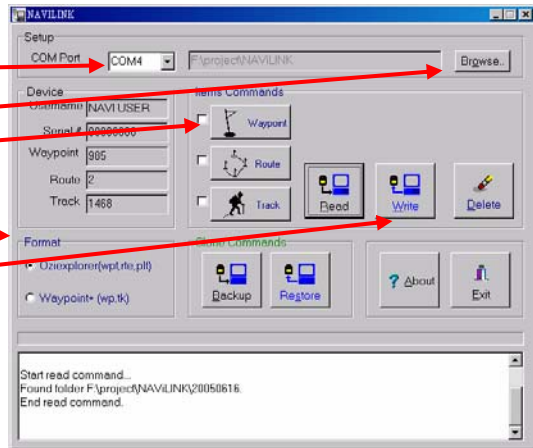

How To: Download and Upload Data (continued)

To Delete Data in GT-11/BGT-11

Step 1: Select proper “COM Port”

Step 2: Change default folder if needed

Step 3: Select the data items in “Items commands” panel to be deleted

Step 4: Press [Delete] in “Items commands” panel to start deleting data

NOTE: Waypoints cannot be deleted if routes exist since waypoints are referenced by routes.

To Backup All Data in the GT-11/BGT-11

Step 1: Select proper “COM Port”

Step 2: Change default folder if needed

Step 3: Press [Backup] in “Clone Commands” panel to start downloading data

Step 4: Save received data

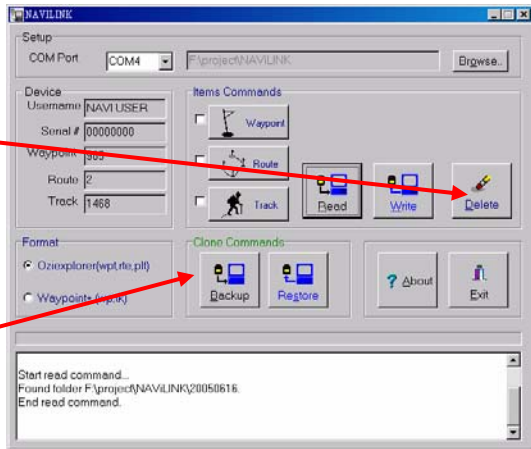

How To: Download and Upload Data (continued)

To Restore All Data in the GT-11/BGT-11

Step 1: Select proper “COM Port”

Step 2: Change default folder if needed.

Step 3: Press [Restore] in “Clone Commands” panel and select file (usually a backup data file) to start restoring

File Naming

File names are composed of device serial number and proper file extension. **NAVI LINK** supports two different file formats:

- **Oziexplorer:** typical file extensions are
 - “.wpt” - Waypoint
 - “.rte” - Route
 - “.plt” - Track
 - “.plt.nmea” - Track in NMEA format
- **Waypoint+:** typical file extensions are
 - “.wp” - Waypoint
 - “.tk” - Track

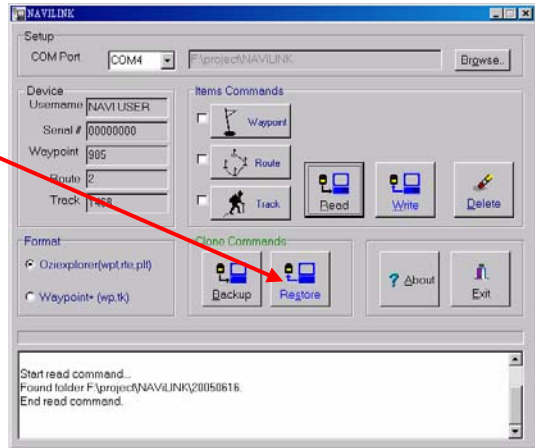

How To: Update the Firmware

From time to time, there will be upgraded new firmware available for download at our web site. You may follow the steps described below to update your **GT-11/BGT-11**

- Make sure that the driver of USB-to-Serial Comm Port has been installed on your PC/Notebook.
- Connect the USB cable between the unit and PC/Notebook.
- Power on the **GT-11/BGT-11**
- Execute the utility, **NAVIFU.exe**, on your PC/Notebook. You will see the display on the screen illustrated as Figure 1, then:
 1. Select correct COM port that the unit is connected.
 2. Click “browse” button to select the file that you want to update. The file is always with an extension file name, .s.
 3. Click “execute” button and wait completion.
- Press the POWER/ESC button of the unit to reset.



Appendix 1

MAP DATUM LIST

No	Abbrev	Description
1	ADINDA	Adindan-MEAN FOR Ethiopia, Sudan
2	ADINDB	Adindan-Burkina Faso
3	ADINDC	Adindan-Cameroon
4	ADINDD	Adindan-Ethiopia
5	ADINDE	Adindan-Mali
6	ADINDF	Adindan-Senegal
7	ADINDG	Adindan-Sudan
8	AFGY	Afgooye-Somalia
9	AIN70	Ain el Abd 1970-Bahrain
10	AINSA	Ain el Abd 1970-Saudi Arabia
11	ANA65	Anna 1 Astro 1965-Cocos Islands
12	ANT43	Antigua Island Astro 1943 Antigua (Leeward Islands)
13	ARC50A	Arc 1950 MEAN FOR Botswana, Lesotho, Malawi, Swaziland, Zaire, Zambia, Zimbabwe
14	ARC50B	Arc 1950-Botswana
15	ARC50C	Arc 1950-Burundi
16	ARC50D	Arc 1950-Lesotho
17	ARC50E	Arc 1950-Malawi
18	ARC50F	Arc 1950-Swaziland
19	ARC50E	Arc 1950-Zaire
20	ARC50F	Arc 1950-Zambia
21	ARC50G	Arc 1950-Zimbabwe
22	ARC60	Arc 1960-MEAN FOR Kenya, Tanzania
23	ASC58	Ascension Island 1958 Ascension Island

24	ASC45	Astro Beacon E 1945-Iwo Jima
25	ASTHI	Astro DOS 71/4-St Helena Island
26	AST61	Astro Tern Island (FRIG) 1961 Tern Island
27	AST52	Astronomical Station 1952 Marcus Island
28	AUST66	Australian Geodetic 1966 Australia & Tasmania
29	AUST84	Australian Geodetic 1984 Australia & Tasmania
30	AYABE	Ayabelle Lighthouse-Djibouti
31	BELLE	Bellevue (IGN) Efate & Erromango Islands
32	BERM57	Bermuda 1957-Bermuda
33	BISSAU	Bissau-Guinea-Bissau
34	BOGOTA	Bogota Observatory-Columbia
35	BUKIT	Bukit Rimpah Indonesia (Banka & Belitung Islands)
36	CAMP	Camp Area Astro Antarctica (McMurdo Camp Area)
37	CAMPO	Campo Inchauspe - Argentina
38	CANTO	Canton Astro 1966 - Phoenix Islands
39	CAPEA	Cape - South Africa
40	CAPCAN	Cape Canaveral - Bahamas, Florida
41	CARTH	Carthage - Tunisia
42	CHTHM	Chatham Island Astro 1971 New Zealand (Chatham Island)
43	CHUA	Chua Astro - Paraguay
44	COREGO	Corrego Alegria - Brazil
45	DEBOLA	Debola - Guinea
46	DJAKA	Djakarta (Batavia) Indonesia (Sumatra)
47	DOS68	DOS 1968 New Georgia Islands (Gizo Island)
48	EAST67	Easter Island 1967 - Easter Island
49	Eur50	European 1950 MEAN FOR Austria, Belgium, Denmark, Finland, France, West Germany, Gibraltar, Greece, Italy, Luxembourg, Netherlands, Norway, Portugal, Spain, Sweden, Switzerland

50	EUR-A	European 1950 MEAN FOR Austria, Denmark, France, West Germany, Netherlands, Switzerland
51	EUR-B	European 1950 MEAN FOR Iraq, Israel, Jordan, Lebanon, Kuwait, Saudi Arabia, Syria
52	EUR-C	European 1950 - Cyprus
53	EUR-D	European 1950 - Egypt
54	EUR-E	European 1950 England, Channel Islands, Ireland, Scotland, Shetland Islands
55	EUR-F	European 1950 - Finland, Norway
56	EUR-G	European 1950 - Greece
57	EUR-H	European 1950 - Iran
58	EUR-I	European 1950 - Italy (Sardinia)
59	EUR-J	European 1950 - Italy (Sicily)
60	EUR-K	European 1950 - Malta
61	EUR-L	European - Portugal, Spain
62	EUR-M	European 1979 MEAN FOR Austria, Finland, Netherlands, Norway, Spain, Sweden, Switzerland
63	FORT55	Fort Thomas 1955 Nevis, St Kitts (Leeward Islands)
64	GAN70	Gan 1970 - Republic of Maldives
65	GEO49	Geodetic Datum 1949 - New Zealand
66	GRA49	Graciosa Base SW 1948 Azores (Faial, Gracias, Pico, Sao Jorge, Terceira)
67	GUAM63	Guam 1963 – Guam
68	GUNSG	Gunung Segara - Indonesia (Kalimantan)
69	GUX	GUX 1 Astro - Guadalcanal Island
70	HERAT	Herat North - Afghanistan
71	HJOR	Hjorsey 1955 - Iceland
72	HK63	Hong Kong 1963 - Hong Kong
73	HUTZU	Hu-Tzu-Shan - Taiwan
74	INDIAB	Indian - Bangladesh
75	INDIAN	Indian - India, Nepal
76	IND54	Indian 1954 - Thailand Vietnam

77	IND75	Indian 1975 - Thailand
78	IRE65	Ireland 1965 - Ireland
79	ISTS68	ISTS 061 Astro 1968 South Georgia Islands
80	ISTS69	ISTS 073 Astro 1969 - Diego Garcia
81	JI61	Johnston Island 1961 - Johnston Island
82	KANDA	Kandawala - Sri Lanka
83	KRG49	Kerguelen Island 1949 Kerguelen Island
84	KERT48	Kertau 1948 - West Malaysia & Singapore
85	KSA51	Kusaie Astro 1951 - Caroline Islands
86	LC61	L.C. 5 Astro 1961 - Cayman Brac Island
87	LEIGO	Leigon - Ghana
88	LIB64	Liberia 1964 - Liberia
89	LUZON	Luzon Philippines (Excluding Mindanao)
90	LUZMD	Luzon - Philippines (Mindanao)
91	MAH71	Mahe 1971 Mahe Island
92	MASWA	Massawa - Ethiopia (Eritrea)
93	MERCH	Merchich - Morocco
94	MIDW61	Midway Astro 1961 - Midway Islands
95	MINAC	Minna - Cameroon
96	MINAN	Minna - Nigeria
97	MNT58	Montserrat Island Astro 1958 Montserrat (Leeward Islands)
98	MPOR	M'Poraloko - Gabon
99	NAHWA	Nahrwan - Oman (Masirah Island)
100	NAHWB	Nahrwan - Saudi Arabia
101	NAHWC	Nahrwan - United Arab Emirates
102	NAPAR	Naparima BWI - Trinidad & Tobago

103	NAD27A	North American 1927 MEAN for antigua, Barbados, Barbuda, Caicos Islands, Cuba, Dominican Republic, Grand Cayman, Jamaica, Turks Islands
104	NAD27B	North American 1927 MEAN for Belize, Costa Rica, El Salvador, Guatemala, Honduras, Nicaragua
105	NAD27C	North American 1927 MEAN FOR Canada
106	NAD27D	North American 1927 MEAN FOR CONUS
107	NAD27C	North American 1927 MEAN FOR CONUS (East of Mississippi River) including Louisiana, Missouri, Minnesota
108	NAD27E	North American 1927 MEAN FOR CONUS (West of Mississippi River)
109	NAD27F	North America 1927 Alaska
110	NAD27G	North American 1927 Bahamas (Except San Salvador Island)
111	NAD27H	North American 1927 Bahamas (San Salvador Island)
112	NAD27I	North American 1927 Canada (Alberta, British Columbia)
113	NAD27J	North American 1927 Canada (Manitoba, Ontario)
114	NAD27K	North American 1927 Canada (New Brunswick, Newfoundland, Nova Scotia, Quebec)
115	NAD27L	North American 1927 Canada (Northwest Territories, Saskatchewan)
116	NAD27M	North American 1927 Canada (Yukon)
117	NAD27N	North American 1927 Canal Zone
118	NAD27O	North American 1927 Cuba
119	NAD27P	North American 1927 Greenland (Hayes Peninsula)
120	NAD27Q	North American 1927 Mexico
121	NAD83A	North American 1983 Alaska, Canada, CONUS
122	NAD83B	North American 1983 Central America, Mexico
123	OBS39	Observatorio Metereo 1939 Azores (Corvo & Flores Islands)
124	EGP07	Old Egyptian 1907 - Egypt
125	HAWAME	Old Hawaiian MEAN FOR Hawaii, Kauai, Maui, Oahu
126	HAWAI	Old Hawaiian Hawaii
127	KAUAI	Old Hawaiian Kauai

128	MAUI	Old Hawaiian Maui
129	OAHU	Old Hawaiian Oahu
130	OMAN	Oman - Oman
131	OS36	Ord. Survey Great Britain 1936 MEAN FOR England, Isle of Man, Scotland, Shetland Islands, Wales
132	OS36B	Ord. Survey Great Britain 1936 - England
133	OS36C	Ord. Survey Great Britain 1936 England, Isle of Man, Wales
134	OS36D	Ord. Survey Great Britain 1936 Scotland, Shetland Islands
135	OS36E	Ord. Survey Great Britain 1936 - Wales
136	PICO	Pico de las Nieves - Canary Islands
137	PIT67	Pitcairn Astro 1967 - Pitcairn Island
138	PONT58	Point 58 MEAN FOR Burkina Faso & Niger
139	PONT48	Pointe Noire 1948 - Congo
140	PORT36	Porto Santo 1936 Porto Santo, Madeira Islands
141	PRV56A	Provisional South American 1956 MEAN FOR Bolivia, Chile, Colombia, Ecuador, Guyana, Peru, Venezuela
142	PRV56B	Provisional South American 1956 - Bolivia
143	PRV56C	Provisional South American 1956 Chile(Northern, Near 19South)
144	PRV56D	Provisional South American 1956 Chile(Southern, Near 43South)
145	PRV56E	Provisional South American 1956 Columbia
146	PRV56F	Provisional South American 1956 Ecuador
147	PRV56G	Provisional South American 1956 - Guyana
148	PRV56H	Provisional South American 1956 – Peru
149	PRVVEN	Provisional South American – Venezuela
150	PRV63	Provisional South Chilean 1963 Chile (South, Near 53South) (Hito XVIII)
151	PUERT	Puerto Rico Puerto Rico, Virgin Islands
152	QATAR	Qatar National – Qatar
153	QORNO	Qornoq - Greenland (South)

154	REUNI	Reunion - Mascarene Islands
155	ROME40	Rome 1940 - Italy (Sardinia)
156	SANTO65	Santo (DOS) 1965 Espirito Santo Island
157	SAOBRZ	Sao Braz Azores (Sao Miguel, Santa Maria Islands)
158	SAPPR	Sapper Hill 1943 - East Falkland Island
159	SCHWA	Schwarzeck – Namibia
160	SELVA	Selvagem Grande - Salvage Islands
161	SGS85	SGS 85 - Soviet Geodetic System 1985
162	SA69A	South American 1969 MEAN for Argentina, Bolivia, Brazil, Chile, Colombia, Ecuador, Guyana, Paraguay, Peru, Trinidad & Tobago, Venezuela
163	SA69B	South American 1969 Argentina
164	SA69C	South American 1969 Bolivia
165	SA69D	South American 1969 Brazil
166	SA69E	South American 1969 Chile
167	SA69F	South American 1969 Colombia
168	SA69G	South American 1969 Ecuador
169	SA69H	South American 1969 Ecuador (Baltra, Galapagos)
170	SA69I	South American 1969 Guyana
171	SA69J	South American 1969 Paraguay
172	SA69K	South American 1969 Peru
173	SA69L	South American 1969 - Trinidad & Tobago
174	SA69M	South American 1969 - Venezuela
175	SASIN	South Asia - Singapore
176	TAN25	Tananarive Observatory 1925 Madagascar
177	TIMBA48	Timbalai 1948 Brunei, East Malaysia (Sabah, Sarawak)
178	TOKTO	Tokyo - MEAN FOR Japan, Korea, Okinawa
179	TKYJP	Tokyo - Japan

180	TKYKR	Tokyo - Korea
181	TKYOK	Tokyo - Okinawa
182	TRST68	Tristan Astro 1968 - Tristan da Cunha
183	VITIL6	Viti Levu 1916 Fiji (Viti Levu Island)
184	WAKE60	Wake - Eniwetok 1960 - Marshall islands
185	WAKE52	Wake Island Astro 1952 - Wake Atoll
186	WGS72	WGS 1972 - Global Definition
187	WGS84	WGS 84-Default
188	YACER	Yacare - Uruguay
189	ZANDR	Zanderiji - Suriname

Warranty and Repair

WARRANTY

LOCOSYS Technology Inc. warrants this product to be free from defect in material and workmanship for 12 months from the date of purchase.

This warranty does not cover the damage due to the shipping of the product, external causes, including accident, abuse, misuse, problems with electrical power, usage not in accordance with product instruction, product that have been repaired or altered by other than LOCOSYS Technology Inc. authorized service person, dealer, problem(s) caused by use of parts and components not supplied by LOCOSYS Technology Inc. upon request. This warranty does not cover any accessories or parts added to product after the product shipped from LOCOSYS Technology Inc.

Product is treated as out of warranty when it is out of the warranted 12 months period, or it has been repaired or altered by other than LOCOSYS Technology Inc. authorized service person, dealer, or which has been subjected to misuse, abuse, accident, or improper installation.

In no event shall LOCOSYS Technology Inc. be liable for any incidental, special, indirect or consequential damages, whether resulting from the abuse, misuse, or inability of use this product or from defects in the product.

Warranty and Repair

REPAPIR

LOCOSYS Technology Inc. will repair the defective products covered under this limited warranty, if they are returned to LOCOSYS Technology Inc. If the product does prove defective, it will be repaired at no charge during the warranty period and at normal repair charge rates when out of the warranty.

To obtain warranty service, contact your local LOCOSYS Technology Inc. dealer. An original or copy of the sales receipt from the original dealer is required. LOCOSYS Technology Inc. will not repair or replace missing components from any package purchased not from authorized dealer.

The repaired product will be warranted subjected to the original warranty only. LOCOSYS Technology Inc. reserves the right to charge a "No Fault Found" fee for product returned as defective where no fault could be found by LOCOSYS Technology Inc. LOCOSYS Technology Inc. owns all parts removed from repaired product.

Product returned by LOCOSYS Technology Inc. to other location beside the Customers' site will bear extra charge and should be credited to the Customers. It is the Customers responsibility to ensure that the package containing the defective product is durable enough to be resistant against further damage and deterioration during transportation. In case of damages occurring during the transportation, the repair is treated as "Out of Warranty".

Federal Communications Commission (FCC) Statement

15.21

You are cautioned that changes or modifications not expressly approved by the part responsible for compliance could void the user's authority to operate the equipment.

15.105(b)

This equipment has been tested and found to comply with the limits for a Class B digital device, pursuant to part 15 of the FCC rules. These limits are designed to provide reasonable protection against harmful interference in a residential installation. This equipment generates, uses and can radiate radio frequency energy and, if not installed and used in accordance with the instructions, may cause harmful interference to radio communications. However, there is no guarantee that interference will not occur in a particular installation. If this equipment does cause harmful interference to radio or television reception, which can be determined by turning the equipment off and on, the user is encouraged to try to correct the interference by one or more of the following measures:

- Reorient or relocate the receiving antenna.
- Increase the separation between the equipment and receiver.
- Connect the equipment into an outlet on a circuit different from that to which the receiver is connected.
- Consult the dealer or an experienced radio/TV technician for help.

Federal Communications Commission (FCC) Statement

Operation is subject to the following two conditions:

- 1) this device may not cause interference and
- 2) this device must accept any interference, including interference that may cause undesired operation of the device.

FCC RF Radiation Exposure Statement:

This equipment complies with FCC radiation exposure limits set forth for an uncontrolled environment. End users must follow the specific operating instructions for satisfying RF exposure compliance. This transmitter must not be co-located or operating in conjunction with any other antenna or transmitter.



Authorized Dealer

Revision History

Part Number	Revision	Date	Note
	1.00	2006/02/10	

Document Number:

© **LOCOSYS Technology Inc. All rights reservedd.**